

CHEVRON



CHEVRON

MEBLE GABINETOWE / EXECUTIVE FURNITURE

szerokość / głębokość / wysokość [cm] width / depth / height [cm]

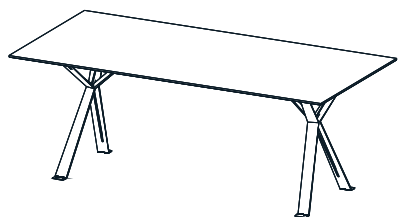

CN 1 / 2
220/240x90x75h

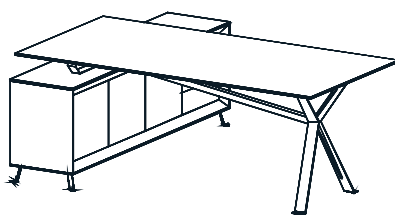

CN 3
200x150x75h

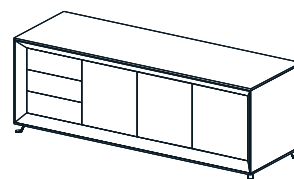

CN 4
150x60x60h

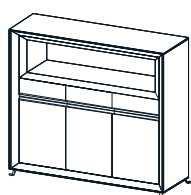

CN 6 / 7
130/180x40x90h

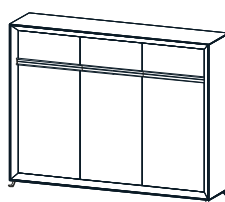

CN 8 / 9
130/180x40x90h



CN 5
54x42x58h

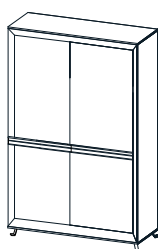

CN 10
90x40x200h

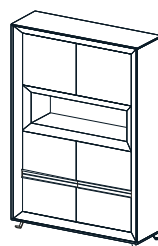

CN 11
90x40x200h

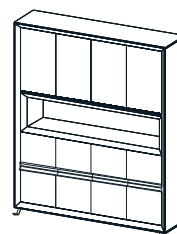

CN 12
170x40x200h

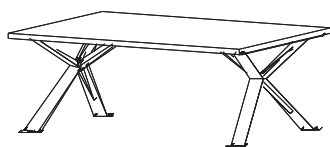

CN 13
120x60x65h



CN 14
fi100x75h

CHEVRON

MEBLE GABINETOWE

OPIS TECHNICZNY

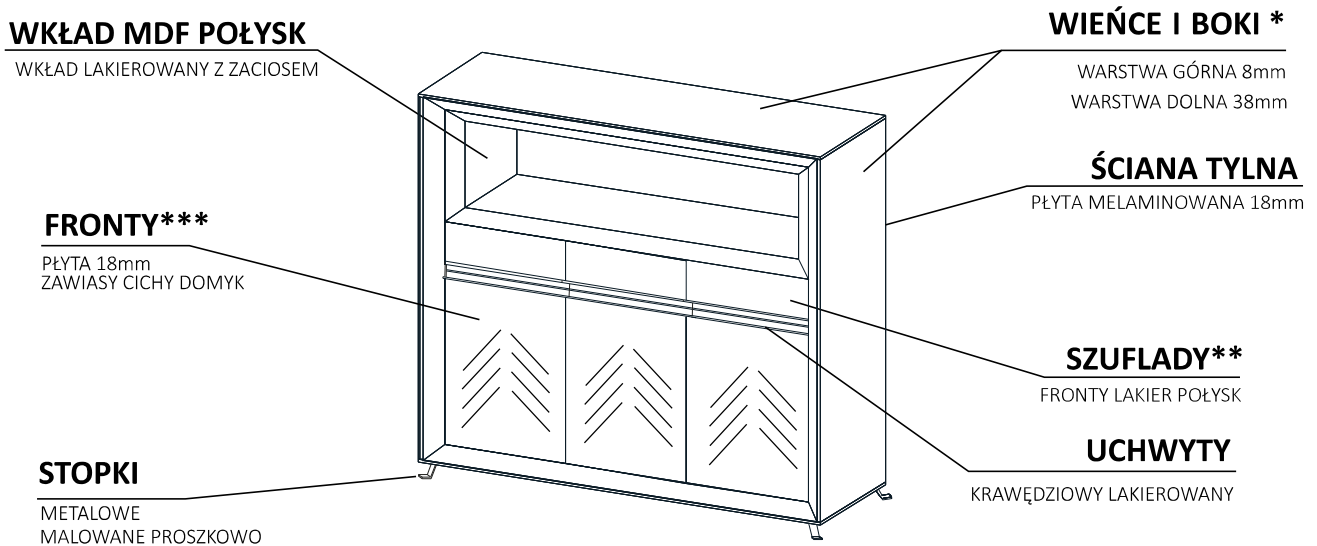
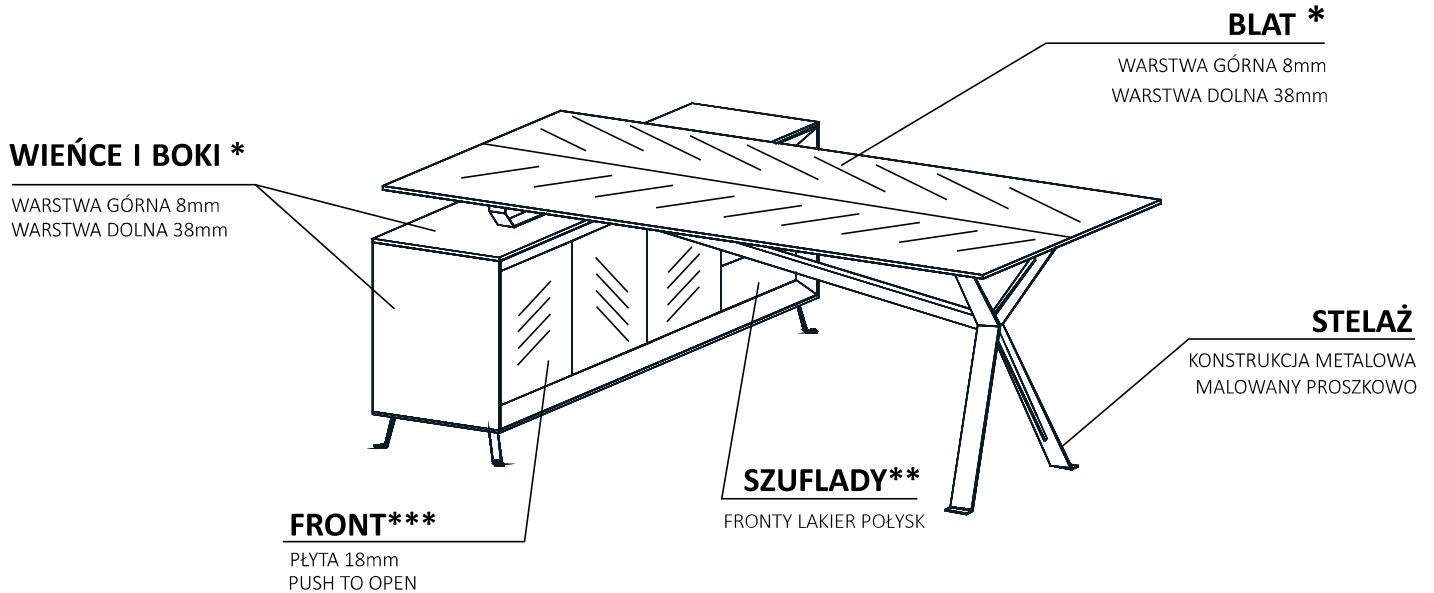

* WARSTWA GÓRNA- MDF OKLEINOWANY FORNIREM LUB PŁYTA MELAMINOWANA.
WARSTWA DOLNA - MDF LAKIEROWANY Z ZACISOEM .

**PROWADNICE TANDEM BLUM, UCHWYT KRAWĘDZIOWY LAKIEROWANY, PEŁEN WYSUW, NOŚNOŚĆ 30 kg

***PŁYTA MELAMINOWANA LUB MDF OKLEINOWANY FORNIREM

OPIS TECHNICZNY

DOSTĘPNA KOLORYSTYKA

1. MELAMINA



- PŁYTA SPIGATO FA93 SELCE (BRAK MOŻLIWOŚCI ZMIANY DEKORU)
- MDF BIAŁY I SZARY
- STELAŻ KOLOR BIAŁY
- UCHWYTY KRAWĘDZIOWE W KOLORZE SZARYM



2. FORNIR

- DOWOLNY FORNIR Z WZORNIKA OKLEIN
- MDF WG KOLORYSTYKI RAL LUB NCS
- STELAŻ WG WZORNIKA METALI
- UCHWYTY KRAWĘDZIOWE WG WZORNIKA METALI

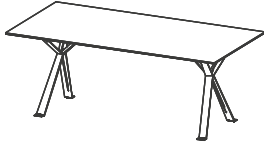
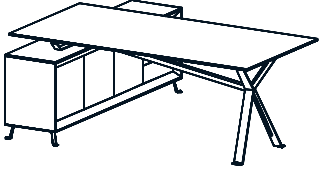
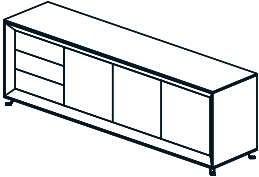
BRAK MOŻLIWOŚCI MODYFIKACJI WYMIARÓW

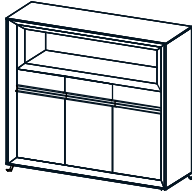
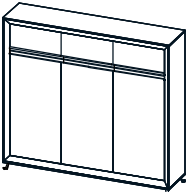
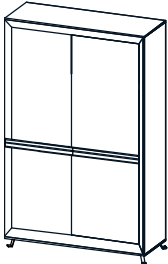
TERMIN REALIZACJI: DO 30 DNI ROBOCZYCH

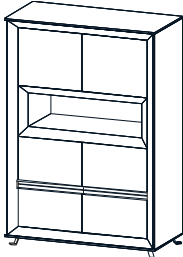
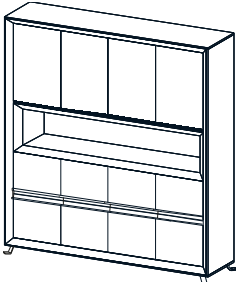
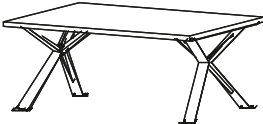
L.P.	ELEMENT	SYMBOL	WYMIAR dł×gł×wys	NAZWA I OPIS	CENA NETTO PLN
1.		CN 1	220x90x75h	Stół konferencyjny	6 944,00
2.		CN 2	240x90x75h		7 410,00
3.		CN 3	200x150x75h	Biurko z pomocnikiem	12 190,00
4.		CN 4	150x60x60h	Komoda niska (3 szuflady + 3 fronty)	6 688,00
5.		CN 5	54x42x58h	Kontener mobilny (3 szuflady)	3 150,00
6.		CN 6	130x40x90h	Komoda (3 szuflady + 3 fronty)	8 130,00
7.		CN 7	180x40x90h	Komoda (3 szuflady + 3 fronty)	10 020,00
8.		CN 8	130x40x90h	Komoda (3 szuflady + 3 fronty)	7 559,00
9.		CN 9	180x40x90h	Komoda (3 szuflady + 3 fronty)	9 445,00
10.		CN 10	90x40x200h	Szafa (4 fronty)	10 520,00

L.P.	ELEMENT	SYMBOL	WYMIAR dłxgłxwys	NAZWA I OPIS	CENA NETTO PLN
11.		CN 11	90x40x200h	Szafa (6 frontów)	11 330,00
12.		CN 12	170x40x200h	Szafa (12 frontów)	17 980,00
13.		CN 13	120x60x65h	Stolik okolicznościowy	4 710,00
14.		CN 14	fi 100x75h	Stolik okolicznościowy	4 400,00

